

ASCE 20

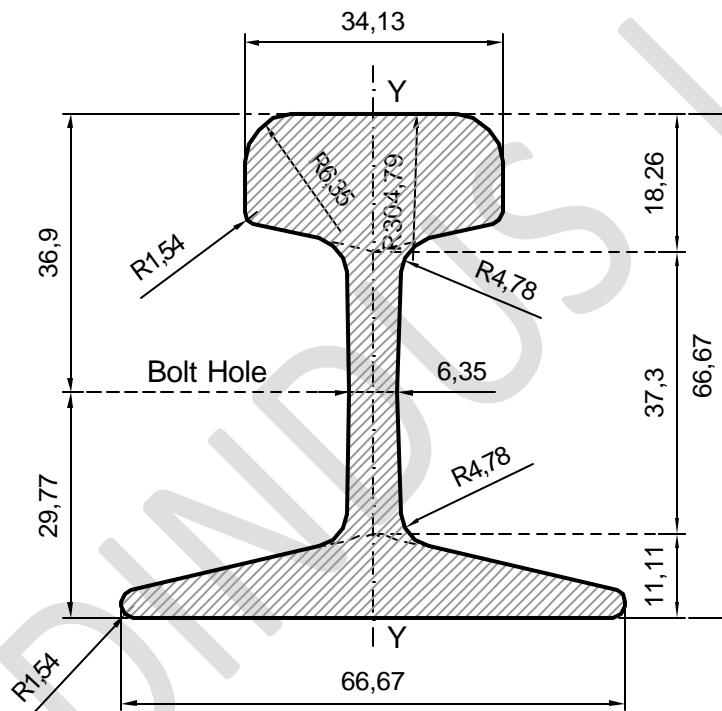

ESC 1:1

Peso Téorico	9.92 kg./m
Sección (A)	12.84 cm ²
Momento de inércia (Ix):	79.88 cm ⁴
Módulo de Resistencia (w) Cabeza:	22.95 cm ³